

Operation GT7000

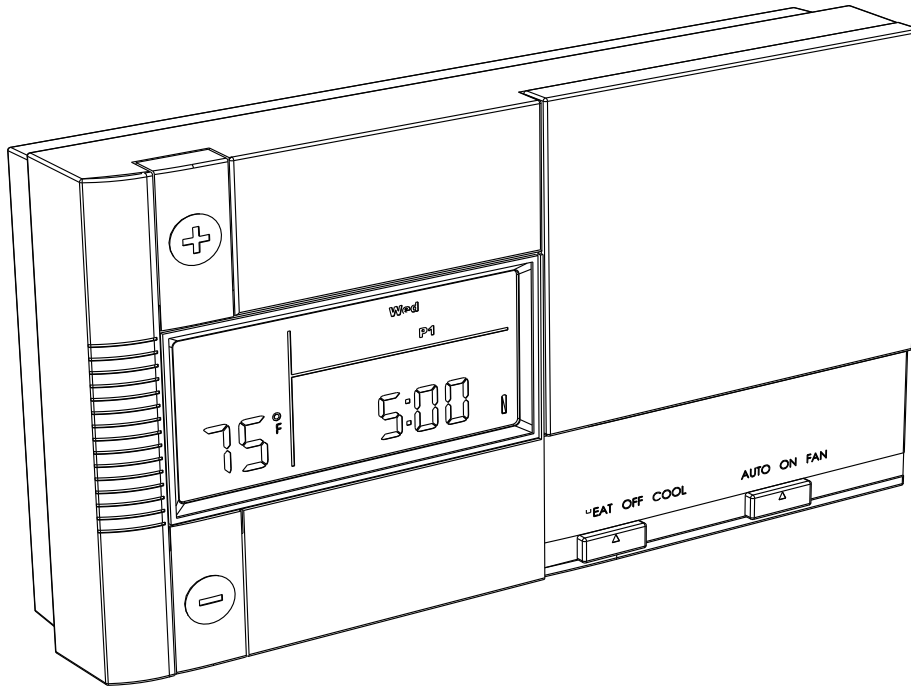

Operation GT7000

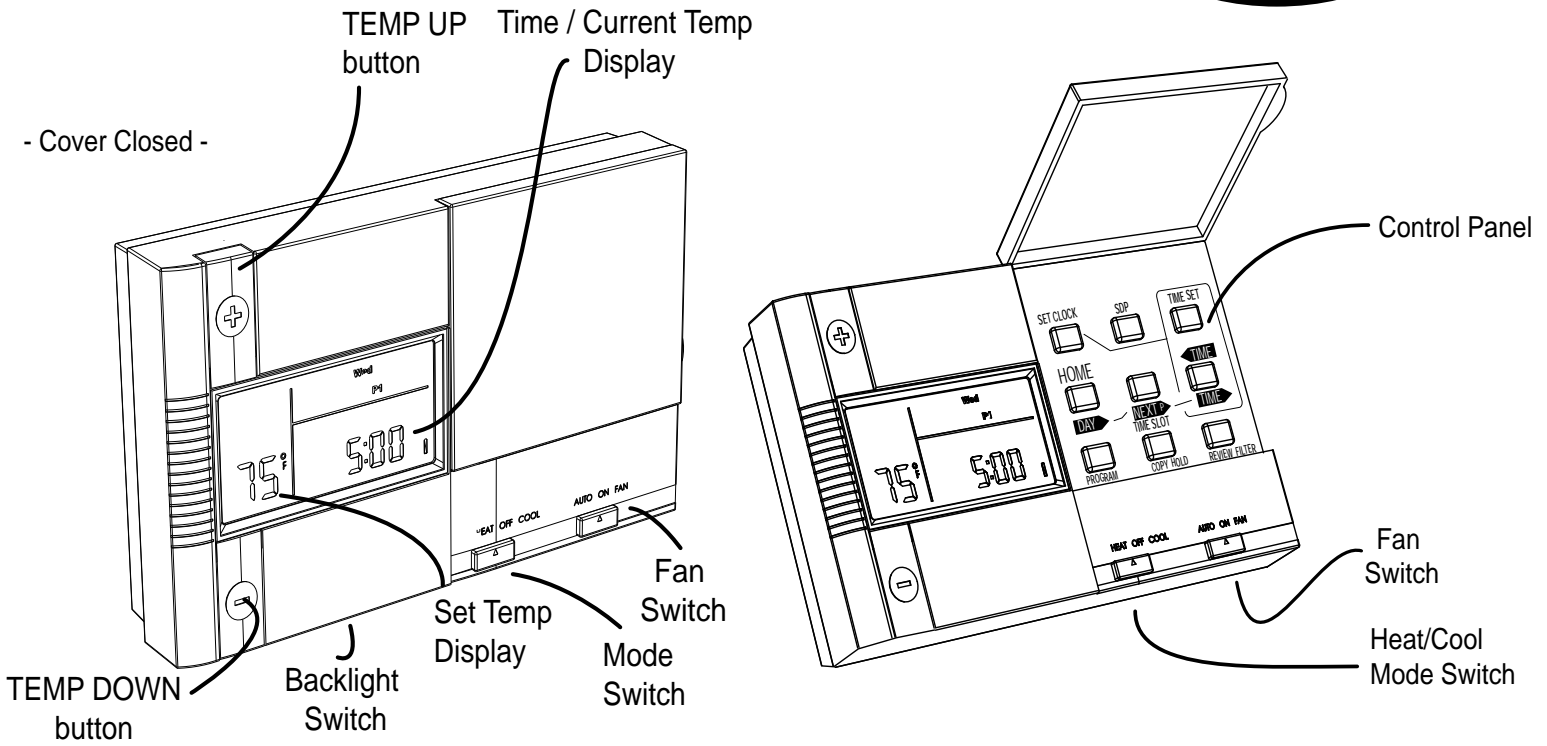
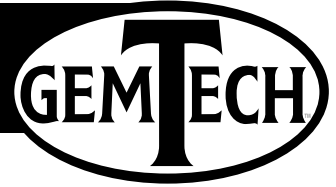

Statement of use: The GT7000 can be used with most 24 volt gas, oil or electric heating and air conditioning systems, single stage heat pumps, gas millivolt and zoned heating systems. **It cannot be used with 120 volt heating systems or 2 stage heat pumps.**

1 Set Clock

Set day of the week -

- Press SET CLOCK *once* to set the **day** of the week. The day of the week display flashes. (Initially **SU** for Sunday)
- Press **TIME** or **TIME** to select the day.
- Press HOME to store your settings. (If HOME is not pressed in 60sec. unit will save your last setting.)

Set time of day -

- Press SET CLOCK *twice* to set the **time**. The time display will flash.
- Press **TIME** or **TIME** to set the time. Press and hold to set the time in the fast mode.
- Press HOME to store your settings.

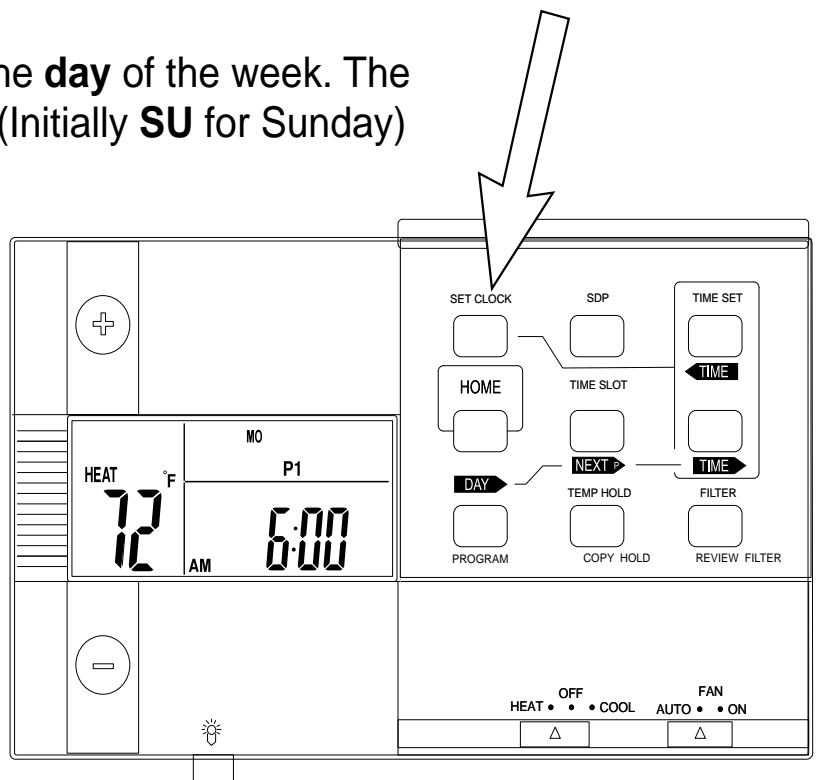

2 Auto-run

This Thermostat comes preprogrammed with an Energy-Star™ approved program. This program is recommended by the EPA for energy efficiency.

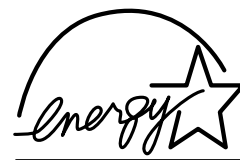

We strongly recommend that you Auto-Run this program for one week, and see if it works for you. If it does not fit your needs you can always input a custom program.

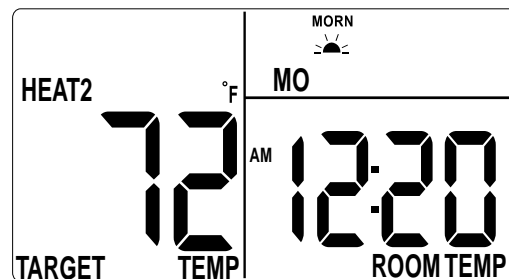

- To Auto-Run the Energy-Star™ program, select HEAT or COOL with the mode switch. The unit is now running the Energy-Star™ program.
- The clock and the ambient temperature are displayed on the right. They alternate every 2 seconds. One of the TIME SLOT icons MORN DAY EVE NITE comes on, this indicates the TIME SLOT active in the Energy-Star™ program.
- The programmed temperature is shown on the left. For program details refer to the Energy-Star™ program chart below.

HEAT	P1	P2	P3	P4	COOL	P1	P2	P3	P4
	6:00am	8:00am	6:00pm	10:00pm		6:00am	8:00am	6:00pm	10:00pm
All Days	70F	62F	70 °F	62 °F	All Days	78F	85F	78F	82 °F

3 Program

NOTE: **60 Second Rule-During** programming, if a button is not pushed within 60 seconds, the unit will go out of the set mode. Everything you have input in this programming will automatically be saved.

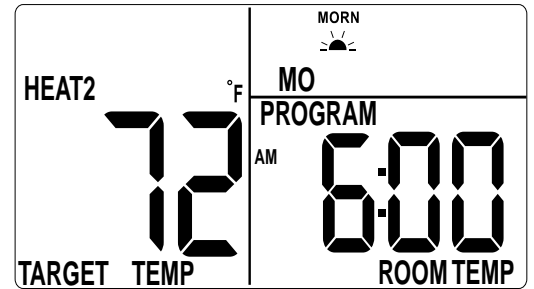

- **Select HEAT with the HEAT/Cool MODE switch.**
- **To select the day you want to program:** Press PROGRAM to enter programming mode. The PROGRAM icon will come on. The day icon will show SU (Sunday). Pressing **DAY** again will advance the day selection.



- **Select the TIME SLOT you want to program:** To change the TIME SLOT (Morn, Day, Eve, Nite) press the **NEXT P** button. The display will cycle through the time periods in sequence. Select **Morn**.
- **Select the desired temperature for that TIME SLOT :** To change the temperature for that TIME SLOT press the TEMP UP / TEMP DOWN buttons.

3 Program cont.

- **Select the time of day you want that TIME SLOT to represent:**

To set the time when MORN will begin, press the  or  buttons to move the set point forward or backward in time.

- **Select the next TIME SLOT and program temp and time:**

Press  the display will show **DAY**, for Period 2. Repeat setting temp and time. Select the remaining TIME SLOT's, **EVE** and **NITE**. Program their temp and time info.

- Repeat the above procedures for each day of the week. Push  button to cycle through the days.

- To COPY the program of the current day to another day, press COPY program once. COPY will display on the LCD. The day icon for the source day will go solid and the day icon for the destination day will flash. Use the  button to select the destination day.

- Press COPY again to confirm the copy. If you decide you don't want to copy,

3 Program cont.

- To program an alternate or "Special Day" program, that you can access at any time, press **DAY** until **PROGRAM** for **SPD** day is displayed. Repeat the procedure above to program temp settings for the Special Day.

When finished programming, press HOME to save your program.

- To program for cooling,
select COOL with the Heat/Cool MODE switch and repeat the above procedure.
- To REVIEW the program you have entered.
Press PROGRAM once to enter Programming Mode.
Then, press FILTER / REVIEW once,

The display will cycle through the programmed times and temps, showing each program for 12 seconds. Starting from Sunday; MORN and ending at Saturday; NITE.

The programmed temperature is shown on the left of the LCD, the programmed time, day and time slot are shown on the right and right top of the LCD respectively.

4 Special Features

SPD

- The "Special Day Program" can be used when you are unexpectedly home or going on vacation and need to activate an alternate heat / cooling program.
- With the MODE switch in HEAT or COOL press the SPECIAL DAY button.
- When the SPECIAL DAY Program is active, all other day settings are ignored
- The SPECIAL DAY program will terminate when the mode switch is moved or if the SPECIAL DAY button is pushed again.

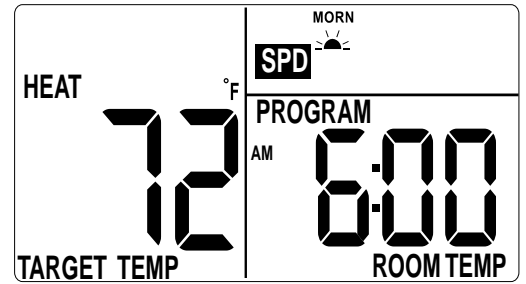

Swing

- Swing setting determines the temperature difference from ON to OFF that the thermostat will command the heating/cooling system to run.
- With the MODE switch in HEAT or COOL, press the **TIME** button.
- The **SET TEMP SWING** icon is displayed. The current setting of temp swing is shown on the display (default at 3).
- To change the swing, push **TEMP UP** or **TEMP DOWN** buttons. The furnace will cycle more at the lower numbers as it tries to keep your set point constant.
- To complete the swing setting, push the **HOME** button.

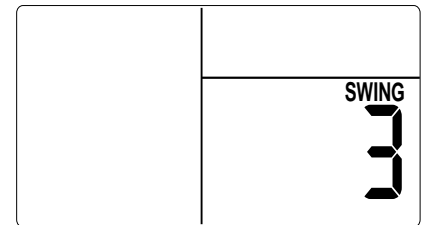

4 Special Features cont.

Manual

- With the MODE switch in HEAT or COOL, push the UP or DOWN button buttons to temporarily change the control temperature by 1 degree per step. Press and hold for faster setting.
- The OVERRIDE icon comes on which shows the displayed temperature may be different from the programmed setting.
- The OVERRIDE is canceled at the start of the next time period, or when the MODE switch is moved, or if **TEMP HOLD** is pressed again.

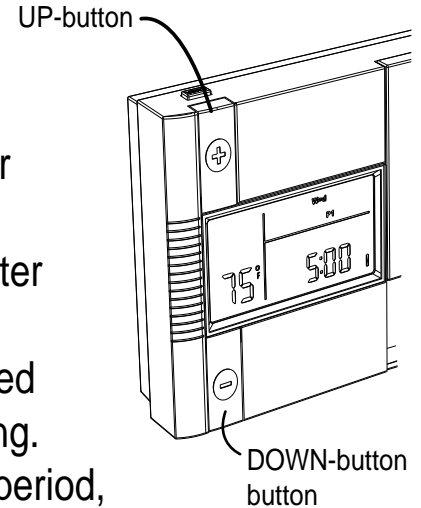

TEMP HOLD

To change and hold the temperature until you return.

- Open the door and push the **HOLD** button. The HOLD icon comes on. Push the UP or DOWN button buttons to set the hold temperature.
- HOLD is canceled if MODE switch is moved, or by pressing **HOLD** again.

Back Light

- Press Back light or any button for 16-20 sec of light. Press and hold for longer light.

4 Special Features cont.

Filter

The life of a heater filter varies depending on many factors, furnace run time, and this will vary from the filter life noted on the filter media.

- The GT7000 has a feature that keeps track of actual furnace run time and reminds you to periodically replace your system's air filter.
- Press the FILTER button once to review the current filter record.
The **FILTER** and **HR** icons come on with accumulated filter hours being displayed.
- Press **TIME** to clear the record. Press again to recover the previous record.
- To see the filter limit setting, press and hold the FILTER button for two seconds.
- To change the filter limit hours setting, press **TIME** or **TIME**. Press and hold for faster setting. The filter limit can be set within 000-500 hours.
- To leave the filter display, press **HOME** or wait 60 seconds.

Lock

Allows you to lock the Program (to prevent any changes in custom settings)

- To enable or disable the program lock, press the following buttons one at a time, in this sequence.
TIME then **FILTER**, then **SET CLOCK**, and last **HOME**.
- The LOCK icon (a pad lock) appears when the system is locked.



4 Special Features cont.

Calibration

NOTE: Your thermostat comes from the factory calibrated to + or - 1 degree F. It is an accurate instrument. If you want your thermostat to display the same temperature as another thermometer in your home, you can adjust its calibration.

To change the calibration:

- Mode switch of the unit must be in the HEAT or COOL position.
- Press the  button.
- Press the Temp Up/Temp Down buttons to adjust the temperature reading.
- Press HOME to save the new setting.

Low Battery

- When the batteries are low, the battery icon will come on and flash.
The two AA Batteries in the unit need to be replaced. In some installations your heater system will stop functioning when the thermostat loses power. **Replace batteries as soon as you see this warning.** The thermostat programs will remain for 30 seconds while the batteries are removed and replaced.
- **Do not take longer than 30 sec** to change the batteries in your unit or you will lose all custom settings and all programming. Only the Energy-Star™ program will remain. Once the batteries are replaced, the system will return to normal in 2 seconds.



4 Special Features cont.

Status Indications

COOL will blink when the COOL is running.

HEAT will blink when the HEAT is running.

15 min Delay

(Only applies on 2 stage conventional heating systems)

If your heating system has a second stage of conventional heat (W2) the thermostat will add the second stage heat source if the first stage does not make the target temp w/in 15 min.

4 Special Features cont.

C or F display

- Centigrade / Fahrenheit selection. The C/F jumper is on the back of the thermostat control unit. Separate the control unit from the wall-mounted terminals.
- When changed, the thermostat must be reset to activate the change. When resetting, all custom settings and programming will be erased and only the Energy-

12/24 hour

- The thermostat can display time in 12 or 24 hour formats. The 12/24 jumper is on the back of the thermostat (see illustration).
- When changed, the thermostat must be reset to activate the change.

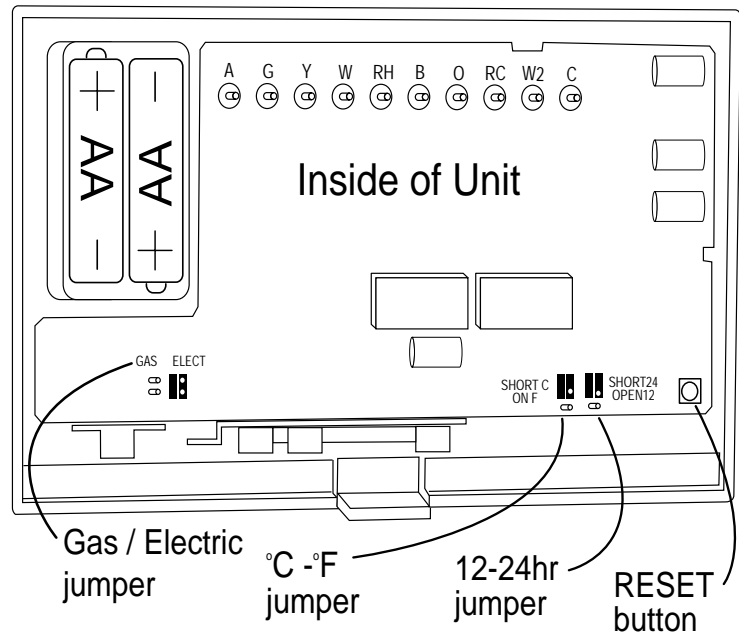

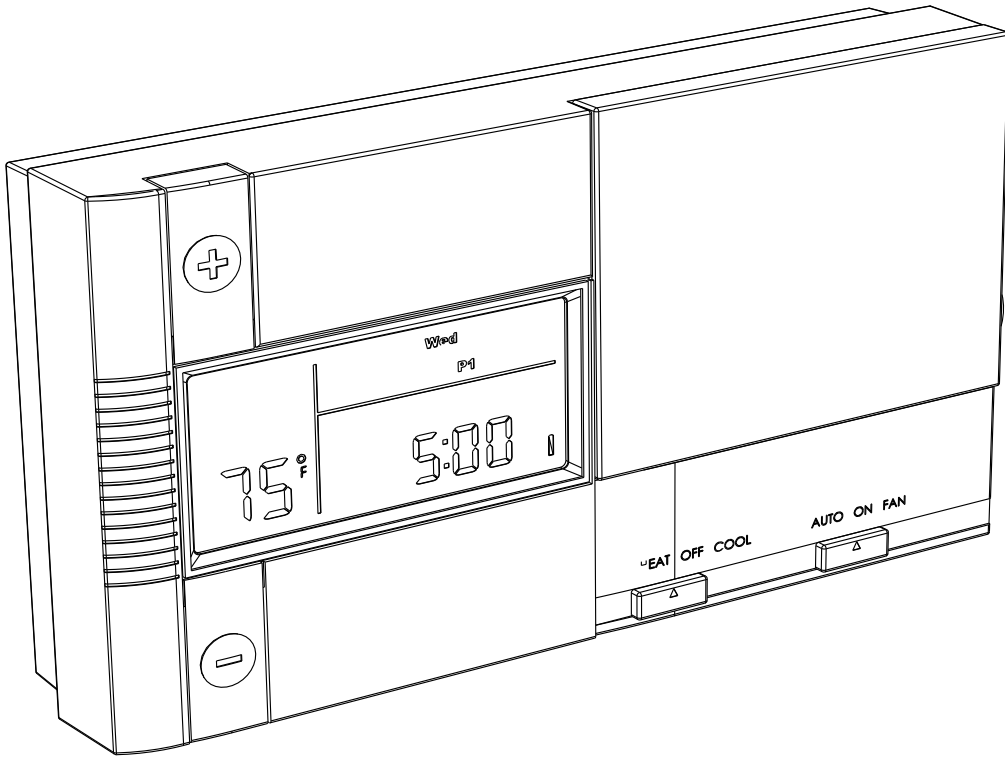

Customer Support Website www.Gemtech-thermostats.com
954-917-4160 Gemaire Distributors

1-507-016